

Article number: 20141V25B252SW

Description: E+G two-way connecting clamp
GN141-V25-B25-2-SW

Measures

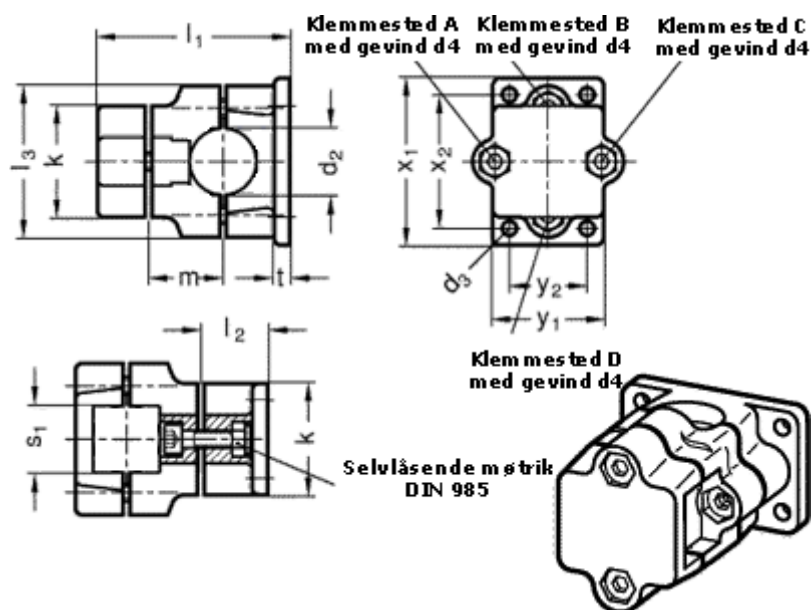

Adjustable clamp lever = GN 911-M 8-35 have to be ordred separately

d2	= 25
d3	= 7
d4	= M 8
k	= 50
l1	= 89
l2	= 30
l3	= 68

m = 36
s1 = 25
t = 7
x1 = 75
x2 = 60
y1 = 50
y2 = 35